

# UNTES<sup>®</sup>

HEATING VENTILATING AIR CONDITIONING



**HEAT RECOVERY FRESH AIR UNITS**  
ASSEMBLING, START UP, MAINTENANCE and USER MANUAL

**Please read this manual first!**

Dear Customer,

Thank you for preferring UNTES. We hope that your product which has been manufactured in modern facilities and passed through a strict quality control procedure will give you the best results. Therefore, we advise you to read through this manual carefully before using your product and keep it for future reference.

- Please read the Operation Manual before installing and starting your machine
- Particularly follow the instructions related to safety.
- Keep this Operating Manual within easy reach. You may need it in the future.

Sincerely,

UNTES Heating Ventilating Air Conditioning Inc.

## CONTENTS

CONTENTS .....	3
1. GENERAL SPECIFICATIONS .....	4
2. TRANSPORTATION and STORAGE.....	6
3. INSTALLATION .....	6
4. ELECTRICAL CONNECTIONS and CIRCUIT SCHEMES.....	7
5. CONTROL UNIT .....	9
5.1. Control Panel .....	10
5.2. Power Control Unit.....	10
5.3. Menu Operations.....	12
5.3.1. User Menu Operations .....	12
5.4. Alarm Codes .....	14
6. MODBUS PARAMETERS .....	15
7. MAINTENANCE and CLEANING .....	16
8. WARNINGS .....	16
9. INFORMATION ABOUT THE FAILURES OF USE .....	17
CONTACT INFORMATION FOR SERVICE and SPARE PARTS .....	20

## 1. GENERAL SPECIFICATIONS

Heat recovery fresh air units are devices that are used to especially meet the fresh air need in the volumes in which static heating and/or cooling are applied and also to remove and exhaust the stale air from the site. While those actions are applied, the units supply a partial heating in winter and partial cooling in summer by exposing fresh air from the outside and exhaust air from the site to each other without letting them mix up in the plate type high efficiency heat recovery. Radial rotary fans which are coupled directly to the motor, balanced under high pressure statically and dynamically and works silent are used in the devices. Unit fans which work only in one-speed mode can be modified to five-speed mode with a fan panel addition.

The whole of the case is produced from galvanized sheet which is corrosion resistant and galvanized iron sheet is dyed with an oven drying powder paint. The case is insulated against noise and heat with rubber insulation material. The potential air leakage is minimized with the precautions taken on the case. There is a drain pan which is powder painted and designed for the drainage of the potential condensation on the heat recovery exchanger. Owing to proper design case structures and high pressure fans, channel connection can be practised.

Units can be supplied without electrical panel to connect an automation system without electrical panel and also supplied with electrical panel and several automation alternatives like freeze protection, air quality sensor or one-five speed fan options.

	URTH 500	URTH 750	URTH 1000	URTH 1500	URTH 2000	URTH 3000	URTH 4000
L [mm]	750	850	900	1000	1200	1200	1300
W [mm]	750	850	900	900	1050	1050	1300
H [mm]	260	290	380	380	430	510	610
A [mm]	160	224	232	240	232	298	331
B [mm]	97	114	208	208	262	262	289
C [mm]	80	80	80	80	80	80	80
D [mm]	250	350	350	350	430	430	515
E [mm]	185	185	270	270	360	440	535
F (Outlet Damper) [mm]	80	80	80	80	80	80	80
F (Inlet Damper) [mm]	110	110	110	110	110	110	110
G [mm]	140	140	140	160	160	180	180
J [mm]	140	140	140	140	140	140	140
K [mm]	240	290	320	320	350	400	400
M [mm]	180	180	180	180	180	180	180
N [mm]	140	140	140	140	140	140	140
O [mm]	210	210	210	240	240	240	240
Y [mm]	220	250	330	330	390	470	570
Z [mm]	370	420	445	445	520	520	645

## STANDARD UNITS

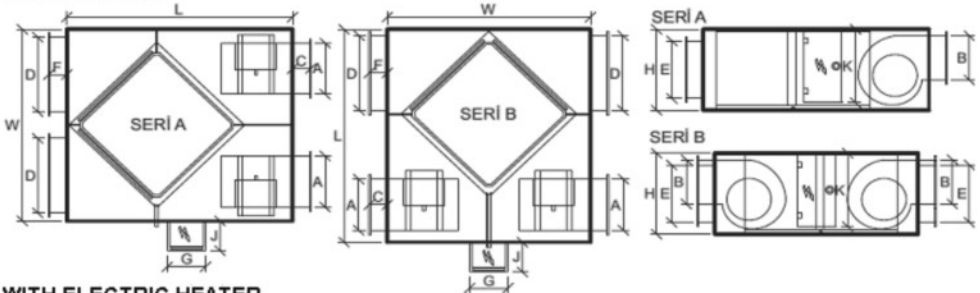

## WITH ELECTRIC HEATER

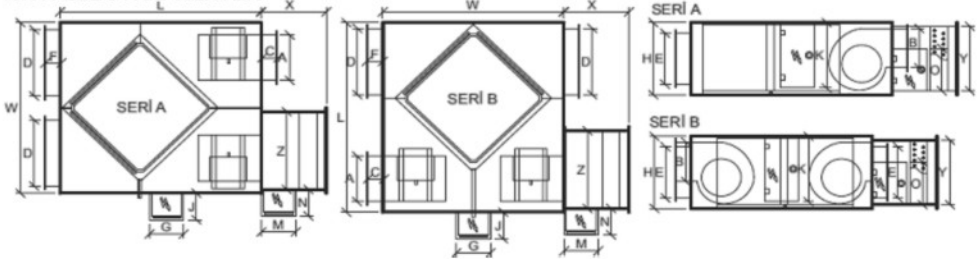

		URTH	URTH	URTH	URTH	URTH	URTH	URTH	
		0500	0750	1000	1500	2000	3000	4000	
Air flow (High Speed)*	[m <sup>3</sup> /h]	565	880	1090	1500	2280	3125	4230	
External Static Pressure (High Speed)*	[Pa]	100	100	100	100	100	100	100	
Aspirator Motor Power	[W]	60	160	184	300	420	550	550	
Ventilator Motor Power	[W]	60	160	184	300	420	550	550	
Noise Level (High/Med./Low.)**	[dBA]	49/47 41	50/45 38	49/48 45	52/51 48	55/53 49	56/55 50	57/54 49	
Electrical Heater THEI Alt. 1 (Ops.)	[kW]	4,0	4,0	5,0	7,0	7,5	10,5	12,5	
Electrical Heater THEI Alt. 2 (Ops.)	[kW]	8,0	8,0	10,0	13,5	12	16,5	25,0	
Electrical Heater THEI Alt. 3 (Ops.)	[kW]	----	----	----	----	19,5	25,5	37,5	
Weight (Three Speed Standard Unit)	[kg]	39	53	65	78	97	109	136	
Main Supply (For Fans)	230 V / 50 Hz / 1 Faz								
Main Supply (Electrical Heater)	400 V / 50 Hz / 3 Faz								

## 2. TRANSPORTATION and STORAGE

- Units shouldn't be removed from package and not be exposed to hard knocks and not drop.
- Units shall be transported and storage in horizontal position. Don't place the unit to top of another.
- Don't drag the unit on a sled.
- Use forklift or the same devices for the small units to lift. For the other big units use suitable devices according to their weights and don't stand under the units while they are lifting.
- Don't carry the unit from pipe connections, door arms or duct connections.
- Don't put high weight that may cause deflection on the unit.
- Be careful about the damper position, it should be closed when the unit stops.
- Don't use the unit in these conditions; over 80% RH, under -20 °C and over 40 °C.
- Chemical substances and other hazardous gas or burn steams should be kept out of touch with the unit itself and unit equipments.
- Before starting-up, units should be storage in a closed area with their packages.

## 3. INSTALLATION

- Firstly decide the unit's working position and service side.
- Observe the lifting rules by installing.
- Install the unit from mounting lugs.
- Use at least M10 stems for connection the unit to the ceiling like the picture below.
- If the unit is on a base, use at least 25 mm anti-vibration chock to prevent vibration.
- Don't connect the channels to outlet of the unit. All channel connections should be connected to the unit with flexible joins.
- Install the unit with horizontal position.
- Observe the basic installation rules by using accessories from other contacts.
- At the connection points of the ducts it should be used gasket in order to prevent air leakage.
- A slope not less than 1/50 should be given to drainage line.

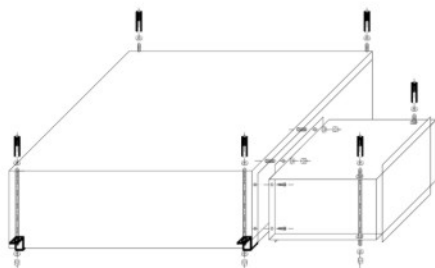

Unit with electrical heater

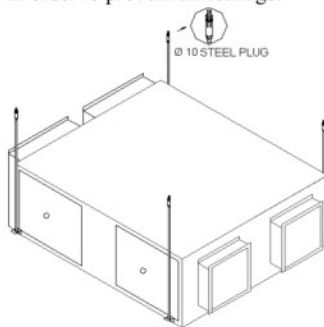

Unit without electrical heater

- This unit is produced with two types named A and B. The connection schema is shown below schematically. You can decide which damper will be inlet and outlet according to in which position the unit installs.

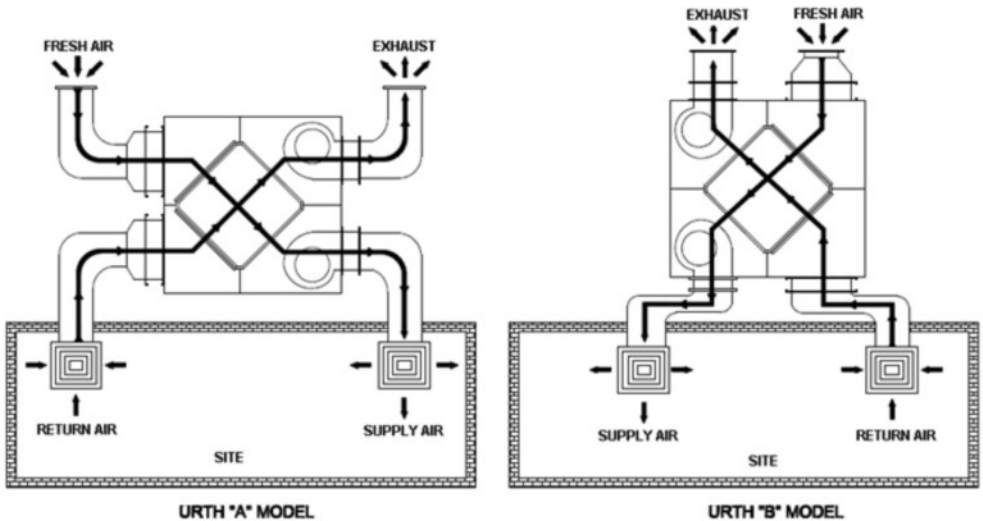

Schema for 'A' and 'B' models

#### 4. ELECTRICAL CONNECTIONS and CIRCUIT SCHEMES

- All electrical connections should be designed according to the national standards and EN 60204.
- The unit must be earthed well.
- All *switch equipment*, cables and all other connection equipments used should be chosen and designed appropriate with the properties of the unit.
- The electrical connections should be made by specialists and it should be made according to electrical diagrams given in the instruction guide and drawings supplied by the manufacturer, properly. For connection problems not proper with the electrical diagram, the unit would be accepted as out of warranty.
- Voltage value on the capacity label must be suitable with line voltage.
- Connection details are shown at the electrical diagram which is found pasted on the connection box or in the user guide.
- The standards make it necessary to earthing all the motors properly. For this reason an earth terminal is found inside the electric panel or terminal box.
- In order to prevent the motors to over work and to work in two phases, the motors should be protected by electric circuits or magnetic breaker.
- If the motor needed to be changed for a reason, it must be change with a new motor which has the same characteristics and it must be CE marked. Otherwise it won't be in the responsibility area of UNTES Company.
- Electrical equipment that will be used for Air handling unit (thermo relay, switches, wires etc.) must be CE marked.





## 5. CONTROL UNIT

Heat recovery units consist of two parts that control panel and power unit.

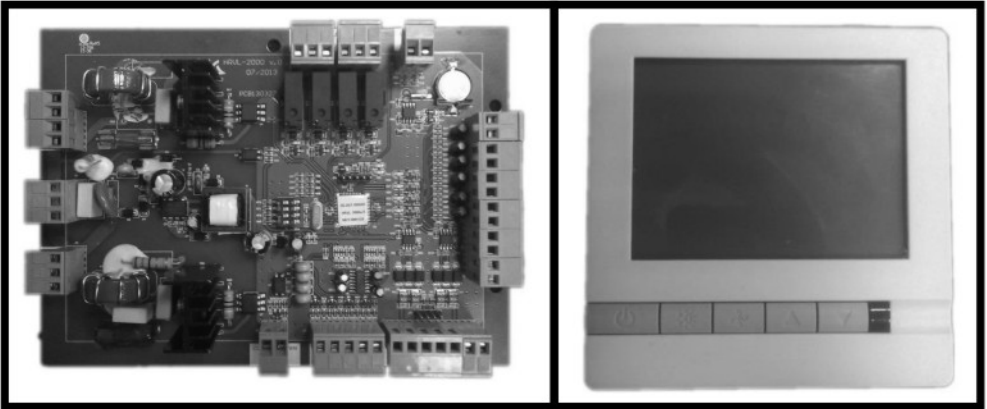

The following events can be made by control unit.

- Via the room control panel mod changes, set point values and changes of the fan speed adjustment can be made.
- Room temperature measurement thanks to room temperature sensor which is located on the control panel
- Digital Inputs that can be assign as alarm and temperature inputs.
- Ability to control 220 VAC Triac , 0-10 V DC proportional and 220 VAC 3 step fan speed
- Can be done stepped heater control
- The possibility of adjust fan speed automatically , depending on CO2 or air quality ratio
- Ability to control electric heater with a PWM output
- Cooling / Heating control functions
- Weekly time programming
- Integration into the building automation system via Modbus RTU with RS485 connection.

## 5.1. Control Panel

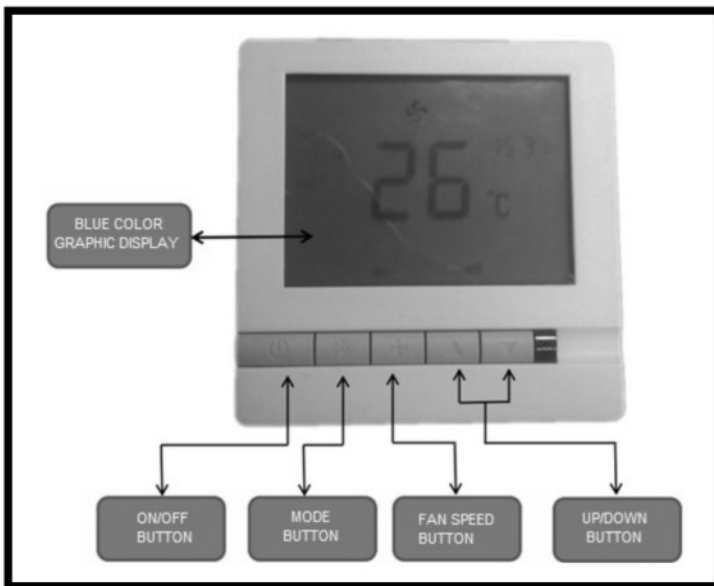

**On/off Key** : The device's power key.

**Mode Key** : Summer/ Winter, is the key to switch between modes of automatic and ventilation.

**Fan speed Key** : Step and automatic fan speed selection can be made

**Up and Down Key** : +/- value for temperature and time settings

## 5.2. Power Control Unit

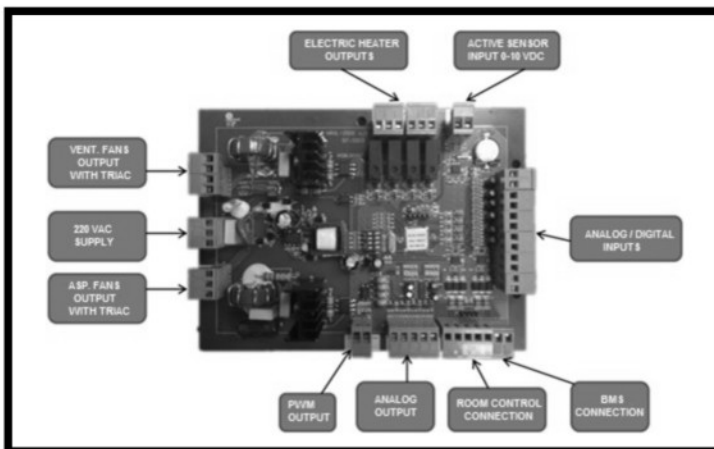

**220 V AC Inlet** : Switched mode power supply (SMPS) is used for the convert AC signal at the input to the DC signal which MCU and other elements can operate.

**Fuse-Varistor Protection** : Fuse is used for overcurrent circuit protection and the varistor is used for protect the circuit from overvoltage. If the system draw overcurrent, the fuse will close the circuit. The moment it passed overvoltage, the varistor is short-circuited and provides the opening of the fuse circuit.

**220 V AC Outlets-With Triac** : The minimum input voltage is 50V and the output voltage is equal to max. input voltage.

**Snubber Filter** : It uses for the filtering the noises coming from the system, formatting the Current and voltage waves (for reducing switching losses) and reducing overshoots during unsteady or transient conditions. Thereby the circuit is protected against over-voltage and current.

**Temperature Sensor Inputs** : Supply, return, outlet and room temperatures is defined and NTC 10K type temperature sensors can be connected. In addition, there is also the possibility of using NTC 100 K, PT 100 or PT 1000 type sensors. Temperature inputs has the ability of making measurements between -50 to +120 degrees.

**Active Sensor Input** : Air quality sensor or CO2 sensors can be connected. These sensors provide increased air circulation with turning the fans faster when the fans taking into auto mode and air quality level rises. Humidity sensor also works same way.

**BMS** : All parameters which extracted to BMS are allowed

**Measuring the Dirtiness of Filters** : 2 filters alarm are defined in the system. These are Return air filter and outdoor air filter alarms. With the assignment of digital 1-6 inputs alarms wait for a certain time to dps contact of the return air filter during working of the device. If contact doesn't come within 30 seconds the device stops the fan and gives alarm.

**Outlet Temperature sensor** : Sensor used in the device program and measures the outlet air temperature. It can measure the air temperature between -50 °C to +120 °C. NTC 10K sensor is used.

**Outlet of Fan Speed** : There are four fan output speed in total. Each one provides information as 0-10V ( analog output ) also it gives 2-4-6-8-10 V output voltages.

**PWM (Pulse Width Modulation)** : PWM and SSR (Solid State Relay) are drivable as on-off or 0-5 Voltage proportionally.

**Hour-Date** : On off times in a day can be set and also according to each day of the week.

## 5.3. Menu Operations

### 5.3.1. User Menu Operations

#### a) Ventilator Step

##### i. Manuel Control



While fan and bottom to up arrow expression flashing on the screen, desired fan speed can be adjust between 1 and 5 by pressing down fan speed button and up/down keys.

Circled taken part in the screenshot shows that the Ventilator is adjusted to step 2. In normal operation only the active step information appears on the screen.

##### ii. Automatic Control



For the adjustment of fan speed in automatic mode, the heating mode on the unit must be activated. While heating mode active and fan and up-down arrows expression flashing on the screen, fan step A can be adjusted by pressing the fan speed button and op-down arrows.

In automatic mode fan speed adjusts the fan speed step depending on the difference between the ambient temperature and the set point. Circled taken part in the screenshot shows that ventilator adjusted automatically. In normal operation mode only the letter A appears on the screen.

#### b) Aspirator Step

##### i. Manuel Control



While fan and bottom to up arrow expression flashing on the screen, desired fan speed can be adjust between 1 and 5 by pressing down fan speed button and up/down keys.

Circled taken part in the screenshot shows that Aspirator is adjusted to step 1. In normal operation mode only the active step information appears on the screen.

##### ii. Automatic Control



For the adjustment of Aspirator speed in automatic mode, the heating mode on the unit must be activated. While heating mode active and fan and up-down arrows expression flashing on the screen, fan step A can be adjusted by pressing the fan speed button and up/down arrows.

In automatic mode fan speed adjusts the fan speed step depending on the difference between the ambient temperature and the set point. Circled taken part in the screenshot shows that aspirator adjusted automatically. In normal operation mode only the letter A appears on the screen.

## c) Operation Settings



### i. Heating Mode Settings

The emergence of the sun icon on the screen is provided by pressing the mode key. To be active of the heating outputs set values must be greater than the room temperature.

Set point adjusts with up/down keys. During set point adjustment, SET statement appears on the screen as in the above picture, next to the temperature setting. In normal operation RT appears on the screen as the following picture and this value refers to instantaneous ambient temperature.

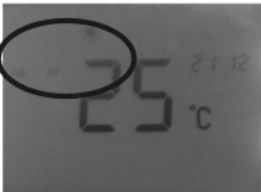

### ii. Ventilating Mode



The emergence of the FAN icon on the screen is provided by pressing the mode key. In this operating mode Aspirator and ventilator can be controlled manually and desired fan steps can be adjusted with following the manual control steps which stated above. The screen image on the side indicates the unit simulated on ventilating mode while aspirator is 5<sup>th</sup> and ventilator 4<sup>th</sup> step.

## d) Date and Time Settings



### i. Date Settings

Date setting is achieved by changing the relevant parameter change by establishing a connection via BMS or service control.

### Time Settings

When the device is in open position that required to keeps the M button pressed for 10 seconds. At the end of 10 seconds the clock icon will be seen that flashes on the screen. Firstly hour adjustment is made with the up/down keys after hour setting, Mode button will be flashing to indicate that the minute part can be changed by re-pressing the Mode button. With up/down keys the clock adjustment can be made, so adjustment gets completed.

## e) Time Programming Settings



With weekly programming opening and closing times can be set separately for each day of the week. When the device is in the open position by pressing the mode button for 10 seconds and switches to the time setting mode. Mode button is pressed until reaching the screens on the left side. At the **ON** position the desired **day and time** for opening the device is adjusted with using up/down keys and At the **OFF** position the desired day and time for closing the device is adjusted with also using up/down keys.

## f) Alarm Status



For fans thermic and for electric heater overheat alarm is activated as standard including 2 different alarms. When alarms which defined to the 1 and 2 inputs are active, the device writes alarm code displayed on the screen section and switches to the appropriate control scenario working position. Related entries must be short-circuited when specified alarms not in use.

## g) Optional Controls



### i. AQ/CO2 Control

This control can be carried out if the control parameter changes via BMS or Service Controller. When this mode is activated the value of AQ or CO2 sensors which has 0-10V feature is connected to the analog input of the card as the ambient temperature and the sensor value is shown on the display alternately. With the condition that the fan mode automatically, the sensor value increases, also the fan speed will be increased.

On the left screenshot, the value coming from the sensor is 90 and corresponding to this value on aspirator and ventilator are working at 5<sup>th</sup> step have been simulated.

## 5.4. Alarm Codes

- AL01 [1] : Fan DSP Alarm
- AL04 [8] : Dirty air filter
- AL05 [16] : Freezing aqueous battery
- AL06 [32] : Over Heating (Electric Heater)



## 6. MODBUS PARAMETERS

The Name of the Parameter	Dec. ID	Min.	Max.	Value
StartStop	0	0	1	
setpoint	1	5	35	
mode	2	0	3	0:Fan Only 1:Heat 2:Cool 3:Auto
supplyFanSpeed	3	0	5	
extractFanSpeed	4	0	5	
D1temperature	8			The temperature value of NTC10K sensor that connected to the device's DI1 input
D2temperature	9			The temperature value of NTC10K sensor that connected to the device's DI2 input
D3temperature	10			The temperature value of NTC10K sensor that connected to the device's DI3 input
D4temperature	11			The temperature value of NTC10K sensor that connected to the device's DI4 input
D5temperature	12			The temperature value of NTC10K sensor that connected to the device's DI5 input
D6temperature	13			The temperature value of NTC10K sensor that connected to the device's DI6 input.
analogInput	14			shows the voltage value as x10 on the input.
frostTemperature	32			in heating valves application, heating valve's frost sensor temperature value.
airQuality	43			The information of air quality between 0-10 V.
carbonDiOxide	45			The information of CarbonDiOxide sensor between 0-10 V.
Humidity	47			The information of humidity sensor between 0-10 V.
AnalogOut1	48			The voltage output value of AO1
AnalogOut2	49			The voltage output value of AO2
AnalogOut3	50			The voltage output value of AO3
AnalogOut4	51			The voltage output value of AO4
relay1Out	96			indicates the relay status.
relay2Out	97			indicates the relay status.
relay3Out	98			indicates the relay status.
relay4Out	99			indicates the relay status.
triac1Out	101			indicates the output of triac.
triac2Out	102			indicates the output of triac.
activeSupplyFanspeed	104			Indicates the active value of the supply fan
activeExtractFanSpeed	119			Indicates the active speed value of the extract fan
activeMode	132			Indicates the active operating mode.
deadBandHeat	133	0	100	10 = 1 C
deadBandCool	162	0	100	
modbusAddress	206	0	247	Device BMS Modbus address.
factoryDefault	207			Resets all parameters to factory defaults.
scheduleEnable	208	0	1	Enables or disables calendar scheduling
mondayStartHourMinute	209	0	2359	
mondayStopHourMinute	210	0	2359	
tuesdayStartHourMinute	211	0	2359	
tuesdayStopHourMinute	212	0	2359	
wednesdayStartHourMinute	213	0	2359	
wednesdayStopHourMinute	214	0	2359	
ThursdayStartHourMinute	215	0	2359	
ThursdayStopHourMinute	216	0	2359	
fridayStartHourMinute	217	0	2359	
fridayStopHourMinute	218	0	2359	
saturdayStartHourMinute	219	0	2359	
saturdayStopHourMinute	220	0	2359	
sundayStartHourMinute	221	0	2359	
sundayStopHourMinute	222	0	2359	
timeDay	223			
timeMonth	224			
timeYear	225			
timeDayOfWeek	226			
timeHour	227			
timeMin	228			

timeSec	229			
alarm	230			
Scenario	231	0	15	Indicates the scenario which selected from Dipswitch.
modePanelLock	236	0	1	
setpointPanelLock	237	0	1	
extractFanSpeedPanelLock	238	0	1	
supplyFanSpeedPanelLock	239	0	1	
fanLogicPanelLock	240	0	1	
parameterspanelLock	241	0	1	
timeProgramspanelLock	242	0	1	
timePanelLock	243	0	1	
startStopPanelLock	244	0	1	

Note: Please contact with us for other parameters.

## 7. MAINTENANCE and CLEANING

- The unit should be run by only authorized personnel with the necessary precautions taken.
- The units shall be cleaned in 6 months periods. This period can be shortened or extended according to customer.
- During maintenance and cleaning the power supply must be switched off.
- Filters shall be change in every three months. If you can't reach an efficient condition, you must change the filters. Dirty filters can cause inefficient conditions.
- Air inlet and outlet dampers shall be cleaned in every three months. This period can be shortened in autumn and winter seasons. In external environments, air inlet and outlet dampers should be checked not to close by leaves, grass, shrubs, etc.
- Plate type heat recovery units shall be cleaned in every six months. Dust and dirt on the heat recovery can decrease the efficiency of the unit.
- Cleaning and controls of drain connections shall be done in every six months.
- Fans were designed working without oil. They shall be cleaned in every two months. You can use vacuum cleaner to take away the dirt from fan's fins.
- Clean the inlet of unit in a period of one year.
- Taking annual service is advised. This annual service includes maintenance steps and observing efficiency and general working conditions of unit.
- Start on the unit after maintain and check that there is any balance or undesirable noise or not.
- After starting current value must be measured and checked it is in limit condition.

## 8. WARNINGS



- Heat recovery fresh air units used for air conditioning. They shouldn't be used for other purposes.
- Installation and start-up procedure can change according to in which country the unit will be used.
- Conformation to international standards is on customer's responsibility.
- It is absolutely forbidden to make a change on the unit either by the user or by the operator. Any damage from such a change would be considered out of warranty.
- The unit should be run by only authorized personnel with the necessary precautions taken.



**9. INFORMATION ABOUT THE FAILURES OF USE**

- Always use the mains switch to disconnect the unit from the mains before carrying out any maintenance work on the unit.
- Take precaution to protect inlet and outlet dampers from rain or snow water.
- Drain line shouldn't be connecting to sewage directly.
- Fans can be caused another potential risk because of their suction ability for free materials. As those materials passing through the fans are ejected out dangerously by the fan, they create a danger. Hard materials can cause damage on fan wings. The protection cages replaced at fan mouths should protect the fan from any particles that might enter in so the cages should be chosen with attention.
- If the protection will be put away, the energy should be cut and locked.
- The doors of the unit and the ducts should not be opened while it is about to stopping or working. The energy should be cut before the entrance of fan section or duct section.

This warranty given by ÜNTES is out of scope, if the unit is used out of its purpose and the following cases come happen:

1. Damage and failures resulting from incorrect use.
2. Damages and failures while loading, unloading and transporting after delivery of the production.
3. Damage and failures resulting from low or high voltage; faulty electrical wiring; using different voltage from written value in the product label or user manual.
4. Failures and damage caused by lightning and fire.
5. Failures resulting from using contrary to the user manual.
6. Failures resulting from interference to the defective product by other than authorized service personnel.

The mentioned defects can be repaired by charging the cost to you and product warranty starts from date of invoice.



# UNTES®

## HEATING VENTILATING AIR CONDITIONING

### CONTACT INFORMATION FOR SERVICE and SPARE PARTS

#### *Head Office & Factory*

İstanbul Yolu 37. Km Kazan – ANKARA/TURKEY  
Phone: +90(312) 818 63 00 (pbx) - Fax: +90(312) 818 61 50

#### *Sales & Ankara District*

53. Cadde 1450. Sokak Ulusoy Plaza No:9 / 50 Çukurambar - ANKARA/TURKEY  
Phone: +90(312) 287 91 00 (pbx) - Fax: +90(312) 284 91 00

#### *İstanbul District*

Atatürk Mah. Bulvar S. No:11 Untes İş Merkezi Küçükbakkalköy Ataşehir - İSTANBUL/TURKEY  
Phone: +90(216) 456 04 10 (pbx) - Fax: +90(216) 455 12 90

#### *İzmir District*

Teknik Malzeme İş Merkezi 1348 Sok. No:5 Kat:2 D:223 Gıda Çarşısı Yenışehir - İZMİR/TURKEY  
Phone: +90(232) 469 05 55 (pbx) - Fax: +90(232) 459 12 92

#### *Adana District*

Fuzuli Caddesi Galeria İş Merkezi 2.Kat No:250 ADANA/TURKEY  
Phone: +90(322) 459 00 40 (pbx) - Fax: +90(322) 459 01 80

[www.unt.es.com](http://www.unt.es.com)

[unt.es@unt.es.com.tr](mailto:unt.es@unt.es.com.tr)